

ShakeAlert® EPICenter Partnership Engagement Guide

A Playbook for Free Choice Learning Environments

April 2025

Free-Choice Learning Environments Advancing Earthquake Resilience



TABLE OF CONTENTS

WHY THIS ENGAGEMENT GUIDE?	3
WHAT IS SHAKEALERT?	3
Why the EPIcenter Partnership and ShakeAlert?.....	4
Feature Focus: Socially Relevant Science at the Pacific Science Center	4
Feature Focus: Forces that Shape the Bay at Lawrence Hall of Science.....	5
Feature Focus: Multi-generational Relevance at the OMSI Epicenter Exhibit	6
WHAT ARE WAYS TO ENGAGE?	7
Preparedness Drills and Exercises	7
Exercise Planning Best Practices	8
Simulation-based Activities with Visitors/Patrons	10
Simulation Activity Best Practices.....	10
Youth Programming	11
Considerations	12
Feature Focus: OMSI Lab Program Explores Magnitude and Intensity.....	12
Feature Focus: One-Day STEM Summer Camp, “Earthquakes 101”	14
Feature Focus: Five-Week After-School Program, Designing for Disasters	15
Interactive Demonstrations	16
Take-Aways	16
Public Events	17
The Great ShakeOut!.....	17
Feature Focus: Shift Happens (All Across Earthquake Country).....	18
Share Your Bright Ideas!	19
REFERENCES	20

WHY THIS ENGAGEMENT GUIDE?

The West Coast is earthquake country! While science and history can help us estimate the likelihood of damaging earthquakes in a given region, seismic events are unpredictable. We do not know exactly where or when the next major quake will occur—**but we can prepare for it!** Free-choice learning environments (FCLEs) are ideal venues to help people better understand both earthquake science and preparedness.

This ShakeAlert® Engagement Guide for Free-Choice Learning Environments is designed for professionals working in museums, science centers, libraries, parks, and other FCLEs to foster imagination, planning, and implementation of informative experiences about earthquake science, as well as the ShakeAlert® Earthquake Early Warning System (AKA ShakeAlert EEW, ShakeAlert System, ShakeAlert) and its many safety benefits. The [EPIcenter Partnership](#)¹ is advancing earthquake resilience through outreach and education about ShakeAlert.

EPIcenter Partnership Focus

While FCLEs range in size, focus, and audience — from urban science museums and small suburban libraries to coastal and community parks — the EPIcenter Partnership’s focus is to advance organizational, community-level, and personal earthquake resilience.

WHAT IS SHAKEALERT?



Managed by the United States Geological Survey (USGS), the ShakeAlert System operates in California, Oregon, and Washington, as well as 146 Tribal Nations; it serves 50+ million people. Using seismometers and Global Navigation Satellite System (GNSS) sensors, ShakeAlert detects significant earthquakes quickly, so alerts can be delivered by USGS-licensed technical partners to alert people by cell phone, potentially giving them seconds to take a protective action before strong shaking is felt. ShakeAlert-powered alerts (whether

through a Wireless Emergency Alert [WEA, similar to an AMBER Alert], Google Alerts, or downloadable apps, such as MyShake) can be delivered to anyone with a cell phone and received on both iOS and Android operating systems.

ShakeAlert can also trigger automated systems (machine-to-machine actions) to slow trains, open firehouse doors, close gas valves, activate generators, and issue a public address, such as in museums, libraries, parks, and other FCLEs.

ShakeAlert-Powered Machine-to-Machine Actions



ShakeAlert™



Saves lives and minimizes injuries



Reduces earthquake damage to property and infrastructure systems



Reduces economic impacts of earthquakes



Speeds the return to normal operations and community recovery

USGS 08.2020

Why the EPIcenter Partnership and ShakeAlert?

The benefits of ShakeAlert EEW are greatest when the public knows about it, understands how to use it, is aware of earthquake hazards in their area, and how to mitigate earthquake risks. With this in mind, the EPIcenter Partnership leverages FCLEs as communicators and community influencers. People continue to turn to FCLEs as trusted sources of information and for experiences that are both scientifically accurate and relevant to their lives. This Engagement Guide includes several examples of how FCLEs are uniquely positioned to engage with public audiences around earthquake science in ways that are socially and locally relevant to people of all ages.

Feature Focus: Socially Relevant Science at the Pacific Science Center

In May 2021, ShakeAlert became publicly available in Washington State for the first time; many organizations and agencies joined to promote this milestone, using it as an opportunity to raise public awareness about earthquake early warning. The Pacific Science Center in Seattle hosted a virtual panel on ShakeAlert as part of its “Science in the City” series, which focused on a range of timely and socially relevant scientific issues.



This live-streamed event featured local experts—a science center director, a seismologist, an emergency manager, a social scientist, and a communications specialist. They answered questions from the public and provided information about ShakeAlert from both geotechnical science and social science perspectives. Images courtesy of OMSI.

Feature Focus: Forces that Shape the Bay at Lawrence Hall of Science

In emergency management circles, it is said that all disasters are local. While the entire West Coast is vulnerable to earthquakes, different communities experience distinct geologic hazards, as well as barriers and assets related to preparedness for and recovery from earthquakes. FCLEs, whether large or small, are familiar with these regionally specific factors and often are already connected to local preparedness efforts. They are well-positioned to present ShakeAlert in ways that are relevant to local and regional learners.

At the Lawrence Hall of Science in Berkeley, California, an outdoor exhibit invites visitors to explore earthquakes and other geologic processes, while appreciating a panoramic view of the landscape those processes wrought. Hands-on elements and informational panels reference local sites and examples, such as the nearby Hayward Fault and the 1989 Loma Prieta earthquake. The Shake-and-Rattle Exhibit is designed to simulate various kinds of ground movement that are observed in actual earthquakes. Architects and engineers use “shake tables” to test whether their buildings will remain stable during an earthquake, making this exhibit relatable to people of all ages.

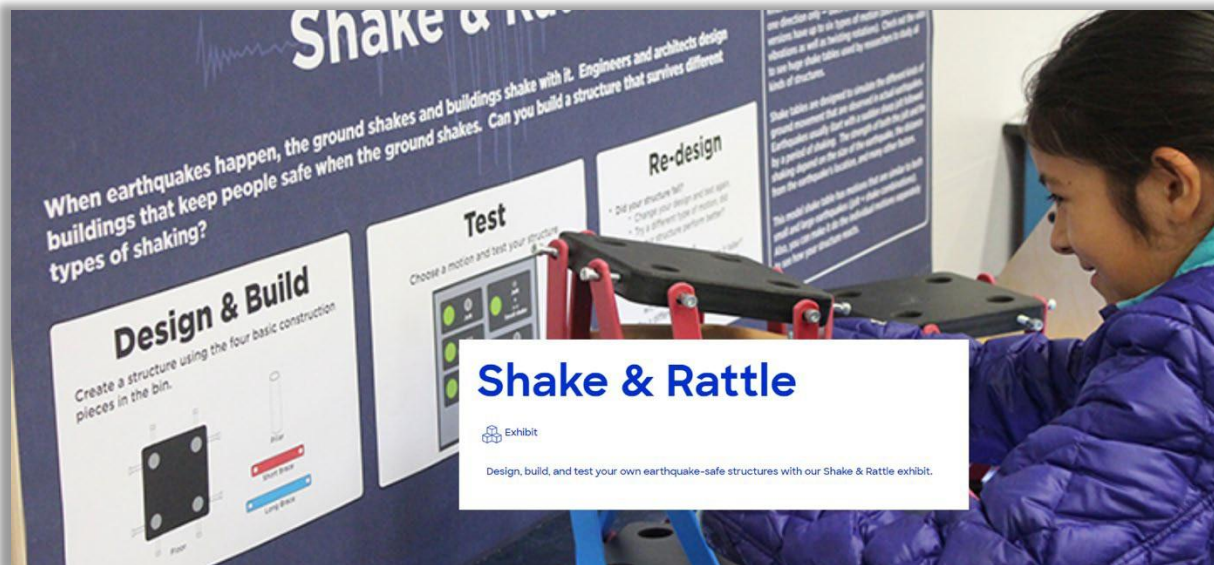

Images courtesy of the Lawrence Hall of Science.

Feature Focus: Multi-generational Relevance at the OMSI Epicenter Exhibit

The Oregon Museum of Science and Industry (OMSI) Epicenter Exhibit is a favorite among museum visitors of all ages. While children may learn about earthquake science and experience earthquake drills in school, they typically do not learn alongside other family members. The Epicenter Exhibit enables many generations to learn together about earthquakes.

The exhibit is accessible via steps and a lift. Child-height buttons invite visitors to select one of three historical earthquakes to simulate. Then, as the floor begins to rumble and shake, visual and audio cues prompt everyone to take the protective action, “Drop, Cover, and Hold On.” Exhibit evaluators noted that the experience sparked conversation for families and other groups; 75 percent of observed participants talked with their group, while 31 percent shared stories about real earthquakes they had experienced.



The ribbed linear structure is mirrored on the floor to create a sense of discomfort as users experience the auditory and physicality of various earthquakes from around the world. Image courtesy of OMSI.

WHAT ARE WAYS TO ENGAGE?

Beyond exhibits and programs, there are a variety of approaches FCLEs can take to engage learners and increase their understanding about ShakeAlert. Regardless of the approach, it is vital to always consider the audience first and incorporate opportunities to build relationships and co-develop programs and experiences with community partners. Featured here are just a few approaches, including:

- Preparedness Drills and Exercises
- Simulation-based Activities
- Youth Programs
- Demos
- Public Events

Engagement Resources

[USGS ShakeAlert](#)

[Earthscope Consortium](#)

[The Great ShakeOut](#)

Preparedness Drills and Exercises

ShakeAlert potentially can give people seconds of warning before earthquake shaking is felt. This brief time is crucial, as it allows people to immediately take a protective action, such as Drop, Cover, and

Hold On, or a modified action by people with disabilities and access and functional needs. The latter may include someone in a wheelchair or walker who locks the wheels, bends over, and uses their arms and hands to cover their head until shaking stops.

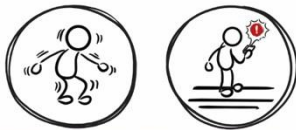

If you FEEL SHAKING or GET AN ALERT...

When possible:			
	DROP!	COVER!	HOLD ON!
Using a cane?			
	DROP!	COVER!	HOLD ON!
Using a walker?			
	LOCK!	COVER!	HOLD ON!
Using a wheelchair?			
	LOCK!	COVER!	HOLD ON!
In a bed?			
	TURN!	COVER!	HOLD ON!
If you are driving ...			
	SLOW DOWN	PULL OVER, STOP	STAY INSIDE

Preparedness exercises (drills, simulations, practice scenarios, tabletop exercises, etc.) can prepare people to respond quickly and effectively in the event of an earthquake or other emergency. These safety-focused activities serve multiple learning purposes:

- ✓ **EDUCATIONAL:** Preparedness exercises, such as drills, support overall awareness of earthquake hazards and can establish or strengthen people’s knowledge of protective actions and procedures.
- ✓ **PROCEDURAL:** Practice makes perfect! In a drill, participants simulate an emergency and rehearse the actions and roles they can take to keep themselves and others safe. Drills can help individuals develop “muscle memory,” allowing them to respond quickly and effectively during a real earthquake.
- ✓ **TRANSFORMATIONAL:** Preparedness exercises may reveal inconsistencies, vulnerabilities, or other needs related to earthquake safety. From these exercises, organizations can learn how to improve their emergency procedures and how to communicate them to others.

Many FCLEs include earthquake drills or other exercises as part of their regular staff emergency training; some FCLEs also include visitors or members of the public in these activities.

ShakeAlert

Whether your institution/organization has an existing earthquake response method or you are developing one for the first time, there is an opportunity to make it “ShakeAlert-powered”— that is, to integrate ShakeAlert into your planned activities.

Exercise Planning Best Practices

There are several considerations and best practices when planning a ShakeAlert-powered earthquake drill or exercise.

Consider the setting

It’s easy to imagine what Drop, Cover, and Hold On look like in a standard office or classroom setting, where a desk or table is typically available to provide cover. However, FCLEs include a range of indoor and outdoor settings, where tables may not be available and other hazards may be present. What does Drop, Cover, and Hold On look like in a planetarium, an art gallery, a maker space, or on an interpretive trail? A practice exercise held in one of these “nontraditional” settings can help people to develop situational awareness and adaptability, so they can protect themselves wherever they are if they get an alert or feel shaking.



Above, OMSI staff demonstrate Drop, Cover, and Hold On on a dock where museum visitors access the Willamette River and the USS Blueback submarine. Image courtesy of OMSI.

For instance, at OMSI, all employees — including administrators, custodians, exhibits staff, and guest services representatives — practice earthquake protective actions in various locations around the museum. Staff practice Drop, Cover, and Hold On in office spaces, in exhibit halls, in the chemistry lab, and in the planetarium. This exercise provides employees with an opportunity to consider how they would protect themselves and potentially help guests/visitors in unique spaces in a science museum.

These different “environments” within your facility or on its grounds enable staff to understand how to self-protect when a table or other sturdy “cover” is nearby, and what to do when there is not. These learned skills are readily transferrable to visitors/patrons on tour with a FCLE staff member if an earthquake were to occur.



Emphasize Drop, Cover, and Hold On

There may not be sufficient time to evacuate a building before strong shaking is felt. If people attempt to run or flee, they risk being thrown to the ground by strong shaking and/or being hit by falling debris. The USGS recommends that, in most situations, if you receive a ShakeAlert-powered alert or feel shaking, immediately Drop, Cover, and Hold On if you are able. If a table or similar sturdy object is available, take shelter beneath it, hold on to the cover's legs so it doesn't migrate away from you during shaking, then stay there until shaking stops. If a cover is not available, drop to the ground, bend over to protect vital organs, and cover your head and neck with your arms and hands. It is best to move away from windows and hanging objects/bookshelves. Immediately move to an interior wall, if possible.

Make it inclusive and accessible

Some people may not be able to Drop, Cover, and Hold On, especially if they use a wheelchair, walker, or cane. It is important for these individuals to move away from windows and hanging objects; lock the wheels on their walker or wheelchair; bend over to protect vital organs; and use their arms and hands to cover their head until shaking stops.

Make it social

FCLEs are social settings and present creative opportunities for participants to practice and debrief together. This can include staff, volunteers, members of the public, or a combination.

Incorporate a ShakeAlert help desk

Offering staff specific information about ShakeAlert is vital! This should include how to get alerts on cell phones, tablets, and other devices, for starters. Consider setting up a "ShakeAlert Help Desk," where trained staff can help others ensure their devices are set up to receive ShakeAlert-powered alerts (whether through WEA, Google Alerts, or downloadable apps, such as MyShake).



Leverage kiosks for messaging

Many FCLEs use digital kiosks, pull-up banners, and [other display media](#) to notify visitors/patrons of exhibits/offerings, upcoming events, schedules, etc. Messaging about ShakeAlert (in anticipation of, during, and following drills) is a great way to further solidify memory of preparedness and protective actions. If your facility/environment includes any ShakeAlert-powered automated actions, such as opening elevator doors and/or starting generators, "advertise" these features on facility kiosks.

Test ideas for new displays with staff

Inviting staff to test ideas for new or modified displays is a great way to both evaluate their understanding and assess the effectiveness of exhibits that demonstrate everything from earthquake magnitude and intensity to how to self-protect when coastal communities are threatened by a tsunami. An "Idea Central" — whether a suggestion box, an online portal, sticky board, or reception area — is a great way to engage audiences with earthquake awareness.

Think beyond the drill

Think bigger and beyond earthquake preparedness and response drills/exercises onsite! Consider leveraging the drill mindset to share other ShakeAlert and earthquake preparedness resources (e.g., readiness checklists for households, so people can be largely self-sufficient for longer periods of time following a major earthquake that may disrupt access to essential services; shelter-in-place supplies; and a “go bag” for evacuation). Many resources can be accessed at [ready.gov](https://www.ready.gov).



Image courtesy ready.gov

Simulation-based Activities with Visitors/Patrons

Simulating an earthquake experience is an ideal way to help visitors/patrons develop muscle memory of self-protective actions when they get an alert or shaking is felt. Some EPIcenter Partnership members (FCLEs) have piloted variations of an earthquake drill that included a simulated ShakeAlert-powered alert, followed by a simulated earthquake using audio and visual cues.

Simulation Activity Best Practices

There are several best practices to consider when planning for simulation-based activities.

Introduce the topic

After your warm welcome of visitors/patrons, ask them how much “earthquake education” they have, by what means they prefer receiving that education/information, preferences for sharing, and what they would like to learn going forward.

Instructions and an invitation to participate in the simulation, followed by feedback after its conclusion, offer valuable lessons that may require a different approach. As importantly, share those experiences and lessons learned with fellow EPIcenter Partnership colleagues!

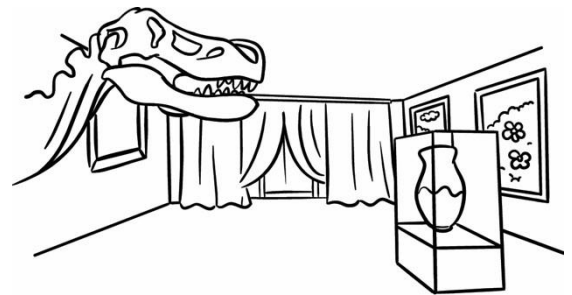

Inform participants about what they can expect

Resources for Drills/Exercises

[ShakeAlert® Tests, Drills and Exercises Toolkit](#)

[ShakeOut Drill Manual for Non-Profits and Other Organizations](#)

[Video: ShakeOut! Get earthquake-ready with OMSI staff](#)

[ShakeAlert Short Videos](#)

Earthquake simulations can include a video component that depicts shaking and is accompanied by an audio alert that is heard over a public address system and can be displayed on screen, mimicking a ShakeAlert-powered alert. The sound of rumbling from buildings and earth shaking can resemble an actual earthquake. Simulations can include lights that flicker, as well as empty boxes that are tossed around the room to simulate shifting items. While simulations should include some realistic elements, it is best to



avoid deliberately frightening participants, which can cause them to freeze, rather than responding in self-protective ways.

Consider the whole community

Simulations can work well with audiences of all ages, but there should be some level of warning to parents that their young children could find the simulation to be disturbing. It is always best to offer visitors/participants an opportunity to excuse themselves at any time!

Learning that uses a number of senses not only creates memory, but can be great fun for individuals and groups! Consider offering copies of (or links to) Rocket's Earthquake Safety Activity Book for children. These are available in multiple languages to reach diverse audiences and can be found on ShakeAlert.org [here](#).

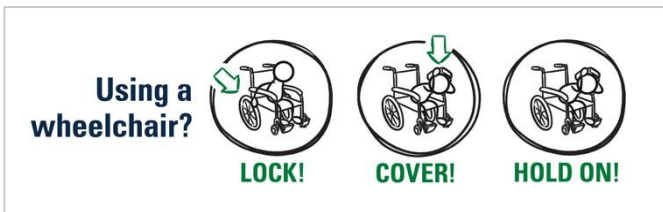

It is also important to consider how people who use wheelchairs, walkers, and canes can safely participate in simulations, so the whole community is engaged and encouraged to self-protect when they receive an alert or shaking is felt. Not everyone can drop to the floor to self-protect. It is important to communicate modified protective

actions that can be taken by people with access and functional needs when they participate in a simulation, visit your FCLE, and even when they are in other environments.

Youth Programming

Youth programming, whether delivered via camps, classes, field trips, or afterschool programs can allow for deeper, more extended exploration of earthquake topics. Research indicates that children are key messengers of preparedness information to their families; this can have a “trickle-up” effect in the community. Children often drill for earthquakes in school settings, so engaging them should seem natural and comfortable for most.

Museums, libraries, parks, and other FCLEs offer a variety of program formats for youth, ranging from a one-time class to a multi-week program. As you consider how to engage youth in learning about earthquakes at summer camp, during story time, or at an after-school club or other settings, consider how learning outcomes can be part of earthquake-focused education.

Considerations

- ✓ **LOCATION HAZARDS:** Where do participating youth live, and are there specific geologic or other hazards in that area?
- ✓ **SPECIAL INTERESTS:** Do participants have a specific interest that could be applied to the topic of earthquakes, such as photography or engineering?
- ✓ **PROGRAM GOALS:** Is the programming's intent to develop students' content knowledge, scientific reasoning skills, and/or preparedness and response actions? Your goal should drive program formats.

Feature Focus: OMSI Lab Program Explores Magnitude and Intensity

OMSI partnered with Oregon Homeschool Science Club to offer a one-hour lab focused on earthquakes for homeschooled students. Participating third- and fourth-graders had some prior exposure to earthquake science and were interested to learn more advanced concepts of magnitude and intensity.

Resources for Magnitude & Intensity Learning

Activity Guide: [Spaghetti Quake](#)

Activity Guide: [Magnitude and Intensity](#)

FAQ: [Magnitude, Intensity, and ShakeAlert®](#)

[How Much Bigger? Calculator](#)

[Earthquake Intensity Scale](#)





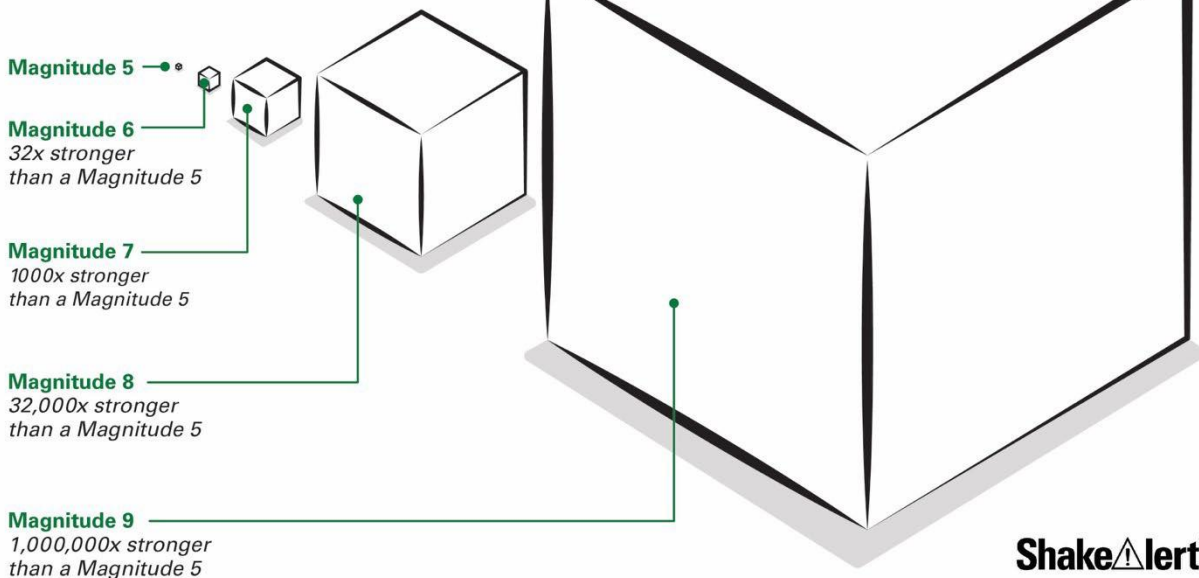





Earthquake Magnitude and Energy Released

A single step in the magnitude scale represents a ~32x stronger earthquake (by energy released).



Students can learn to quantify energy released by earthquake magnitudes and the Modified Mercalli Intensity Scale.

Earthquake Intensity Scale Modified Mercalli Intensity (MMI)

	INTENSITY	SHAKING	DESCRIPTION
	I	Not Felt	Not felt except by a very few under especially favorable conditions.
	II	Weak	Felt only by a few persons at rest, especially on upper floors of buildings.
	III	Weak	Felt quite noticeable by persons indoors. Many people do not recognize it as an earthquake. Standing cars may rock slightly, vibrations are similar to a passing truck.
	IV	Light	Felt indoors by many, outdoors by few. At night, some are awakened. Dishes, windows, and doors are disturbed. Sensation like a heavy truck striking a building. Standing cars rock noticeably.
	V	Moderate	Felt by nearly everyone; many awakened. Dishes and windows are broken. Unstable objects are overturned. Pendulum clocks may stop.
	VI	Strong	Felt by all; many frightened. Some heavy furniture moved. A few instances of fallen plaster. Damage is slight.
	VII	Very Strong	Negligible damage to buildings of good design/construction. Slight to moderate damage in well-built/ordinary construction. Considerable damage in poorly built/constructed structures. Some chimneys broken.
	VIII	Severe	Slight damage to specially designed structures. Considerable damage to ordinary construction, including partial collapse. Damage is great in poorly built structures. Fall of chimneys, columns, monuments, and walls. Heavy furniture overturned.
	IX	Violent	Considerable damage to specially designed structures; well-designed frame structures are thrown out of plumb. Damage is great in substantial buildings, with partial collapse. Buildings shifted off foundations.
	X+	Extreme	Some well-built wooden structures destroyed; most masonry and frame structures with foundations are destroyed. Rails are bent.

OMSI Lab Program participants also learned how citizen science data contributes to scientists' understanding of earthquakes by examining "[Did You Feel It?](#)" reports from a past seismic event.

Students read real-life reports from people who experienced the 1994 Northridge earthquake. For example, "I was driving home from work and it felt like I had a flat tire. I pulled off the road to check, and as I stopped the car, I saw the chimney on a nearby house collapse!" Students then used these reports to color-code a "[Shake Map](#)," showing how shaking intensity varied around the epicenter.

Feature Focus: One-Day STEM Summer Camp, "Earthquakes 101"

For the "Earthquake 101" program, OMSI partnered with a local Latina-serving organization, Adelante Mujeres, to lead a full day of earthquake-themed activities at a STEM summer camp for girls aged 7–12 years. The focus was on games, crafts, and similar hands-on activities leveraged as tools to explore earthquake science.

About Using Food Activities

Some children may experience food insecurity; consider inviting students to eat their edible creations at the end of the activity.

ALWAYS alert children and their parents/guardians about possible food allergies.

Consider offering vegan and kosher products, whenever possible and practical. It is important to respect religious, cultural, and dietary needs of participants.

Asking about these things in advance can inform your planning efforts.

Morning Session: Plate Tectonics

In the morning, students learned about the driving forces of earthquakes by collaboratively solving the "Plate Tectonics Puzzle" and modeling crustal processes with "Edible Plate Tectonics." Students paired and used Slinky® toys to model different types of earthquake waves, then created paper city models to show how waves could affect buildings of different heights.

Afternoon Session: Engineering

The afternoon session focused on earthquake engineering, starting with "Pasta Quake" as an introduction to magnitude. First, students used popsicle sticks to explore the function of bracing in seismic engineering; then they applied those concepts to an open-ended building challenge, using toothpicks and marshmallows. The day ended with an onsite earthquake drill, where students practiced Drop, Cover, and Hold On in response to a simulated ShakeAlert-powered alert.



Chicas Summer Camp participants work together to assemble the Tectonic Puzzle Map (left) and model seismic waves using a Slinky (right). Images courtesy of OMSI.

Feature Focus: Five-Week After-School Program, Designing for Disasters

An extended program format, such as an after-school club, allows for deeper engagement and provides opportunities to align earthquake learning with topics and activities of interest to students.

OMSI has a partnership with Self Enhancement, Inc. (SEI), a community-based organization in Portland, Oregon. OMSI was invited to bring ShakeAlert programming to their multi-week, after-school program for middle-school students. Since this program needed to engage middle-schoolers and align with SEI's goals, it was deliberately designed to present earthquake science in a way that prioritized fun, creativity, and empowerment. Design Thinking (DT) was chosen as a framework to explore earthquakes generally and ShakeAlert, specifically.

Design Thinking is an approach to problem solving that is focused on people; it begins with empathy, which then informs the process of imagining, creating, testing, and improving design-based solutions to actual problems. Within this construct, the challenges and problems associated with earthquakes are reframed, not as science problems specifically, but as human problems to be addressed through DT.

During this five-week after-school program, students first practiced the DT process through a time-tested activity, "The Perfect Present." In subsequent weeks, they applied a similar process to explore challenges related to earthquakes, and considered design-based solutions for earthquake detection, earthquake alerting, earthquake-resilient building, and emergency preparedness kits.

Resources for Earthquakes 101 Summer Camp

Activity Guide: [ShakeAlert Interactive Demos \(see Mapping Earthquakes, Tectonic Puzzle Map, Graham Cracker Plate Tectonics, and Swaying Buildings\)](#)

Activity Guide: [Seismic Slinky](#)

Activity Guide: [Spaghetti Quake](#)

Activity Guide: [Designing Earthquake-Resistant Structures](#)

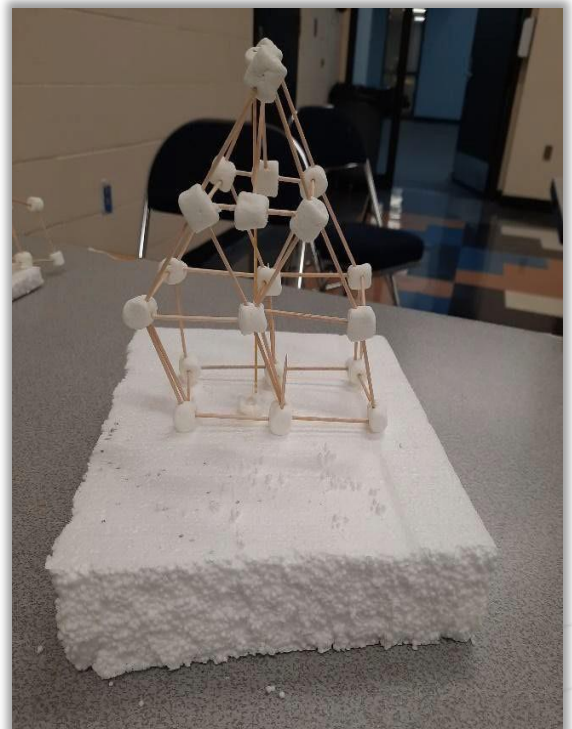
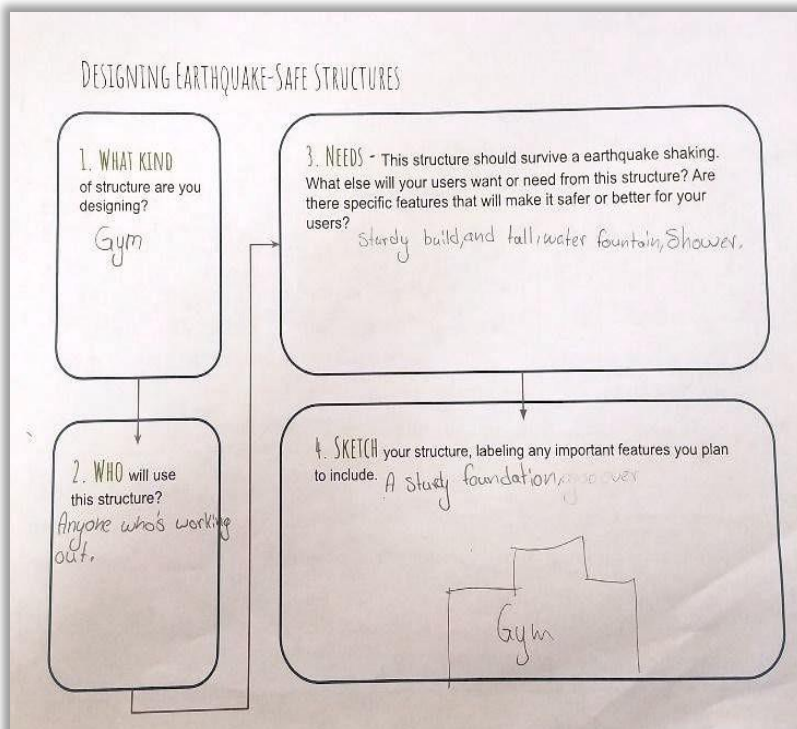

In Designing for Disasters, SEI students design earthquake-proof structures to suit the needs of specific users. Images courtesy of OMSI.

Interactive Demonstrations

Resources for Interactive Demos

General: [Tips for leading hands-on activities from NISE Network](#)

Activity Guide: [Interactive Demonstrations](#)

[Educational Videos](#)

Interactive demonstrations or “demos” are effective ways to engage a large number of people using short, memorable experiences. The best demos include hands-on materials, open-ended discovery, and two-way conversations between facilitators and learners. A tabletop demo may be supplemented by more static informational materials, such as flyers and posters. This format is particularly well-suited for informal settings, such as a museum hall, a farmers’ market, a science fair, or a festival.

Demos are standard fare in a science museum. These short, hands-on activities are flexible to engage visitors of all ages and can be led by both novice and experienced educators. For example, youth from OMSI’s Teen Science Alliance lead a tectonic mapping activity, and a volunteer helps visitors assemble a paper model.

The point is to illustrate the effects of earthquake waves on buildings of different heights.

Designing for Disasters Program Resources

Activity Guide: [Designing for Disasters](#)

Recorded Presentation: [Designing for Disasters: Learning About Earthquakes Through the Lens of Design Thinking](#), presented at American Geophysical Union Fall Meeting, 2022

Demos can travel well! Fairs, festivals, and similar events are valuable opportunities to engage community members outside the boundaries of a park, museum, library, or other FCLE facility/environment. Hands-on activities are great ways to initiate

a conversation about earthquakes. At right, OMSI staff bring ShakeAlert demos and information to the Oregon State Fair.



Image courtesy of OMSI

Take-Aways

Simulations and interactive demonstrations are best complemented with hand-outs and “take-aways” for both staff-oriented drills and those conducted for visitors/patrons. This is a great time to discuss many earthquake risk reduction strategies people can implement at home and in their communities.

Earthquake Risk Reduction Strategies

ShakeAlert Earthquake Early Warning is just one tool for mitigating earthquake impacts and staying safe!

 Develop a Family Emergency Plan	 Prepare and Organize Disaster Supplies	 Secure Top-Heavy Furniture and Water Heaters to Wall Studs	 Regularly Practice Drop-Cover-Hold On or Other Situational Alternatives
 Know How to Turn Off Gas Valves in the Event of a Gas Leak	 Catalog Belongings and Protect Yourself Financially with Earthquake Insurance	 Encourage Mitigation Policy Measures	 Strengthen Homes and Buildings with Seismic Retrofits

We cannot predict or prevent an earthquake, but earthquake early warning, personal preparedness, and earthquake mitigation can save lives, reduce damage, and speed recovery.

ShakeAlert

USGS 08.2020

There is a multitude of resources available at [ShakeAlert.org](https://www.shakealert.org) (<https://www.shakealert.org>) that are both print-ready and also can be distributed digitally via email, social media, and on websites. These make great take-aways following a simulation, demo, or exhibit.



Public Events

Public events can take a variety of forms among EPIcenter Partnership members, from small-scale offerings to full-scale, multi-day extravaganzas. Regardless of the scale or format, FCLEs can use public events to focus attention on ShakeAlert and earthquake science, bringing people together in ways that are both informative and fun. Importantly, they are safety-focused for those who live in and visit earthquake country!

The Great ShakeOut!

Every year on the third Thursday in October, individuals and organizations all over the world participate in the [Great ShakeOut](https://www.shakeout.org) (<https://www.shakeout.org>), an international earthquake drill and preparedness event. The entire month of October is a great time to increase earthquake awareness and preparedness. In FCLEs, hosting displays, exhibits, demos, drills, programs, etc. during this month offers multiple touch-points, as people will likely be hearing about earthquake preparedness all month long across multiple media in their communities. Consider a wide range of activities related to earthquake science and safety, such as hosting a preparedness fair featuring local emergency managers and earthquake scientists; they love to talk about earthquake science and safety!



Feature Focus: Shake or Treat Earthquake and Emergency Preparedness Fair

For FLCEs across the region, it is important to be prepared internally and to support their communities in becoming more earthquake resilient. One creative example of such work comes from the San Bernardino County Museum, which found a festive way to engage families in emergency preparedness through its annual Shake or Treat Earthquake and Emergency Preparedness Fair.



Typically held on the Saturday after the ShakeOut Day, this event blends Halloween fun with practical knowledge, creating an opportunity for visitors to learn how to prepare themselves, their families, their homes and their neighborhoods for wildfires, earthquakes, and other disasters. Families are invited to arrive in costumes and explore the museum’s parking lot, transformed into a preparedness fair featuring hands-on demonstrations, resources and emergency supplies from local businesses and county departments, and, of course, candy - no tricks, just treats!

By combining seasonal festive celebration with critical preparedness messaging, the Shake or Treat event highlights how museums can play a meaningful role as trusted community resources while offering families a fun, accessible way to build resilience in the face of earthquakes and other emergencies.

Anniversary Reminders

Public events occurring on the anniversary of notable earthquakes can commemorate past seismic events, while reminding the public of the continued need for preparedness and safety.

Additional Resources

- [Tectonic Trivia at OMSI 2024](#)
- [Description of SBCM Shake or Treat event](#)
- [Kamome Storytime-recorded video](#)
- [Earthquake Early Warning System for the PNW](#)

Feature Focus: Tsunami Awareness

For those living in or visiting coastal communities, earthquakes introduce the possibility of a tsunami. Increasing awareness of what people should do if they are in a coastal community (and if they are aware of local tsunami zones) is an important role FCLEs can play in the safety of their staff, visitors, and patrons.

If you're on the coast, wait for shaking to stop, then ...



Go to high ground or inland immediately!



Stay there until local officials say it's safe to return.

The shaking is your tsunami warning. Tsunami waves may arrive for hours.

The Multnomah Public Library in Portland, Oregon, seized this opportunity when it hosted a special [story time](#) to coincide with the 10-year anniversary of the 2011 Japanese earthquake and tsunami. The story time featured a read-aloud of the book “The Extraordinary Voyage of Kamome: A Tsunami Boat Comes Home,” along with thematic, hands-on activities. Adults and children also learned about earthquake and tsunami safety, including how to receive and respond to ShakeAlert-powered alerts.

Other Tsunami Resources

- [FEMA Tsunami National Risk Index](#)
- [Tsunami Protective Action Videos \(ShakeAlert.org\)](#)

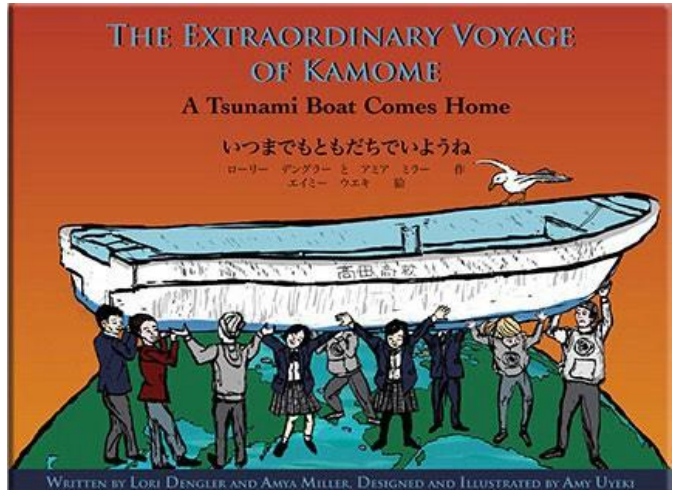

Pictured above is the book featured at the Multnomah Public Library story time.

Share Your Bright Ideas!

Do you have creative ideas for engagement programming that promotes earthquake risk resilience? We’d love for you to share them with others in the EPIcenter Partnership. If you have an activity, demo, or approach that helps communities better understand and prepare for earthquakes, please reach out to Scott Randol at srandol@omsi.edu.

Questions about ShakeAlert®?

If you have technical questions about the ShakeAlert® Earthquake Early Warning System or just want to learn more about how it works, contact Robert-Michael de Groot, Coordinator for Communication, Education, Outreach, and Technical Engagement at rdegroot@usgs.gov.



REFERENCES

- Adams, R. M., Tobin, J., Peek, L., Breeden, J., McBride, S., & de Groot, R. (2022). The generational gap: Children, adults, and protective actions in response to earthquakes. *Australasian Journal of Disaster & Trauma Studies*, 26(2).
- American Alliance of Museums. (2021, October 13). Museums and trust 2021. American Alliance of Museums. <https://www.aam-us.org/2021/09/30/museums-and-trust-2021/>
- Association of Children’s Museums (2022, August 26). Key concepts: Trust. <https://childrensmuseums.org/2022/08/23/acm-trends-report-key-concepts-trust/>
- Horrigan, J. B. (2018). *Libraries, trust and social capital*. Urban Libraries Council. https://www.urbanlibraries.org/files/ULC_White-Papers_LIBRARIES-TRUST-AND- SOCIAL-CAPITAL.pdf
- Kurtulmus, F. (2022). Science, trust, and justice: more lessons from the pandemic. *Social Epistemology Review and Reply Collective*, 11(6), 11 – 17.
- Spencer, B. & Rojas-Salas, M. (2019). *The Epicenter/El Epicentro Summative Evaluation Report*. OMSI Engagement Research & Advancement Division. <https://omsi.edu/wp-content/uploads/2023/02/Epicenter-report-v-6.28.pdf>